

# Product Data Sheet

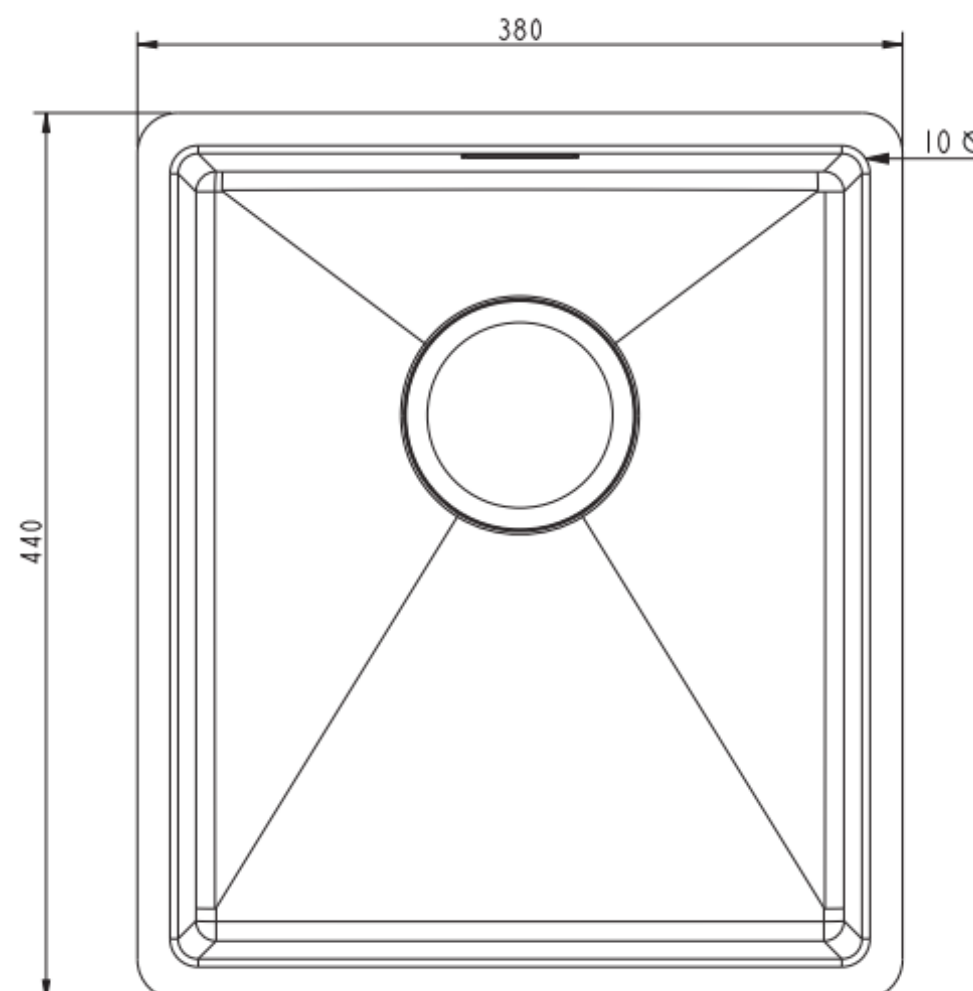

Prima Code	CPR518
Description	PRIMA+ 1.0B R10 INS SINK STST
Colour	Polished Stainless Steel
Material	SS304 Stainless Steel
Stainless Steel Thickness (mm)	0.8
Finish	Polished
Fitting Style	Inset & Undermount
Sealant Strip (Incl./Separate)	N/A
No. Drainers	0
No. Tap Holes	0
Dimensions (mm)	W380 x D440 x H190
Main Bowl Dimensions (mm)	W340 x D400 x H190
Cut out depth (mm)	See downloads for Inset or Undermount
Cut out width (mm)	
Minimum cabinet width (mm)	450
Main Bowl Radius (mm)	10
Small Bowl Radius (mm)	10
Drainer (RH/LH)	No Drainer
Reversible	No
Accessories (included)	Waste, overflow, clips & Cut out guide
Accessories (optional)	CPR106 Plumbing kit
Waste disposer compatible	Yes
Boxed/Sleeved packaging	Boxed
Guarantee	Lifetime